

This manual contains IMPORTANT WARNINGS and INSTRUCTIONS. Equipment in this manual is exclusively for painting purposes. Do not use for other purposes. The operator shall be fully conversant with the requirements stated in this instruction manual including important warnings, cautions and operation and correct handling. Read and understand the instruction manual, before use and retain for reference.

INSTRUCTION MANUAL (For Overseas Sales)

HVLP Compliant Spray Gun

LPH-400-LV LOW VOLUME LOW PRESSURE



Our products are produced as per international standards ISO9001

Main Specifications	Maximum Working Pressure	6.8 bar (98 PSI)
	Noise level (LAeq1)	69.4 dB(A)
	Temperature range	5~40 °C

Model	Type of feed	Nozzle orifice ϕ mm(in)	Air cap set	※1 Atomizing air pressure bar (PSI)	Air pressure inside air cap bar (PSI)	Fluid output ml/min	Air consumption l/min(cfm)	Pattern Width mm(in)	Weight g(lbs)
LPH-400-124LV	Gravity	1.2 (0.047)	LV4	1.1 (16)	0.7 (10)	90	270 (9.5)	260(10.2)	380(0.84)
LPH-400-134LV		1.3 (0.051)				110		280(11.0)	
LPH-400-144LV		1.4 (0.055)				130		290(11.4)	
LPH-400-154LV		1.5(0.059)				140		295(11.6)	
LPH-400-164LV		1.6 (0.063)				150		300 (11.8)	
LPH-400-184LV		1.8 (0.071)				190		320 (12.6)	

※1. Atomizing air pressure means air pressure at gun inlet when trigger is pulled and air flows.

PARTS LIST

No.	Description	Q'ty
1	Air cap set	1
2	Fluid nozzle-fluid needle set	1
2-1	Fluid nozzle	1
2-2	Fluid needle set	1
3	Needle packing set	1
4	Needle packing seat	1
5	Body set	1
5-1	Air nipple	1
5-2	Fluid nipple	1
6	Pattern adj. set	1
7	Air valve seat set	1
7-1	O ring	1
8	Air valve	1
9	Air valve spring	1
10	Fluid adj. guide	1
11	Fluid needle spring	1
12	Fluid adj. knob	1
13	Air valve shaft	1
14	Air adj. set	1
15	Trigger stud	1
16	Trigger	1
17	E stopper	1
18	Filter	1
19	Brush	1
20	Instruction manual	1

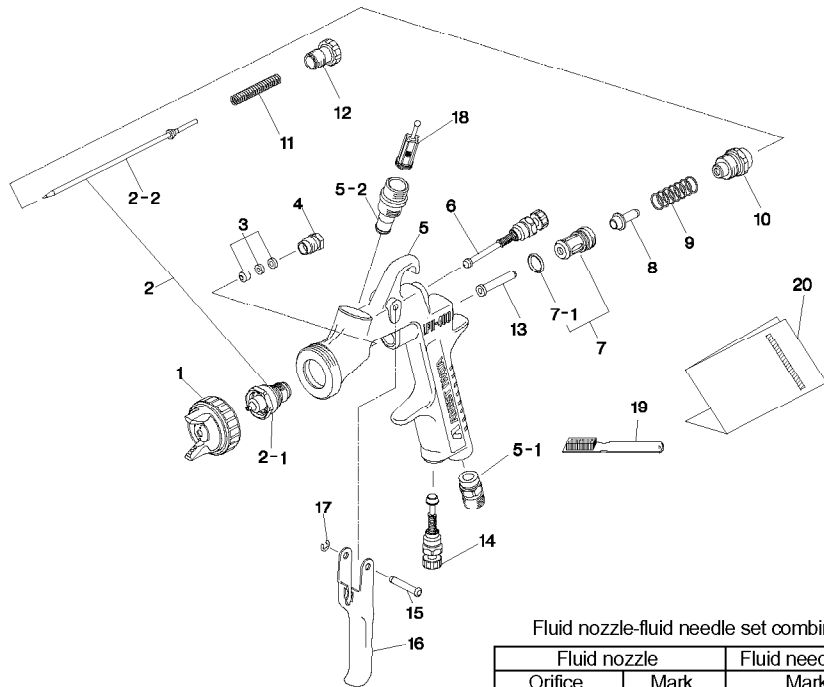

Fluid nozzle-fluid needle set combination

Fluid nozzle		Fluid needle set
Orifice ϕ mm(in)	Mark	Mark
ϕ 1.2(0.047)	400LV/12	40012
ϕ 1.3(0.051)	400LV/13	20015
ϕ 1.4(0.055)	400LV/14	
ϕ 1.5(0.059)	400LV/15	
ϕ 1.6(0.063)	400LV/16	
ϕ 1.8(0.071)	400LV/18	20020

When ordering parts, specify gun's model, part name with ref. No. and marked No. of air cap set, fluid nozzle and fluid needle.
 ◆ Marked parts are wearable parts.

SAFETY WARNINGS

FIRE OR EXPLOSION HAZARD

1. Fluid and solvents can be highly flammable or combustible.
 - Use in well-ventilated spray booth.
 - Avoid any ignition sources such as smoking, open flames, electrical hazard, etc.
2. NEVER use HALOGENATED HYDROCARBON SOLVENTS (1.1.1 TRICHLORINE, ETHYL CHLORIDE, etc.), which can chemically react with aluminum and zinc parts and cause an explosion. Be sure that all fluids and solvents used are chemically compatible with aluminum and zinc parts.
3. To reduce the risk of static sparking, grounding continuity to the spray equipment and object being sprayed must be maintained.



MISUSE HAZARD

1. NEVER point gun in the direction of human body.
2. NEVER exceed the maximum safe working pressure of the equipment.
3. ALWAYS release air and fluid pressures before cleaning, disassembling or servicing. For emergency stop and prevention of unintended operation, a ball valve installed near the gun to stop air supply is recommended.



HAZARD CREATED WHILE COATING MATERIALS ARE ATOMIZED AND SPRAYED

1. Toxic vapors produced by spraying certain materials can create intoxication and serious damage to health.
 - Use the gun in well-ventilated areas.
 - Always wear protective eyewear, gloves, respirator, etc., to prevent the toxic vapor hazard, solvents and paint from coming into contact with your eyes or skin.
2. Noise level mentioned in main specifications was measured at 1.0 m behind the tip of the gun, 1.6 m height from floor.
 - Wear earplugs if required.



OTHER HAZARDS

1. NEVER modify this product for any applications.
2. NEVER enter working areas of robots, reciprocators, conveyors, etc., unless machines are switched off.
3. NEVER spray foods or chemicals through the spray gun.
4. If something goes wrong, immediately stop operation and find the cause. Never use till you have solved the problem.

INSTALLATION

IMPORTANT

This gun should be operated by adequately trained operators only. Ensure that the gun has not been damaged during transportation. Clean, dry air should be supplied to the gun. When you use this gun for the first time after purchasing, adjust fluid needle packing set. slowly tighten fluid packing seat and loosen a bit when fluid needle set does not return smoothly, and adjust so that fluid needle set smoothly moves.

1. Connect an air hose to air nipple tightly.
2. Connect an applicable cup, PCG-6P-M (Option), to fluid nipple tightly.
3. Flush the gun fluid passage with a compatible solvent.
4. Pour paint into container, test spray and adjust fluid output as well as pattern width.

HOW TO OPERATE

Set the spray distance from the gun to the work piece as near as possible within the range of 100-200 mm (3.9~7.9 in). As this gun is operated at low air pressure, high transfer efficiency will not be obtained if the spray distance is too far.

Keep fluid output as small as possible to the extent that the job will not be hindered. It will lead to better finishing with fine atomization.

The gun should be held so that it is perpendicular to the surface of the work piece at all times. Then, the gun should move in a straight and horizontal line. Arcing the gun causes uneven painting.

Recommended paint viscosity differs according to paint property and painting conditions. 12 to 23 sec. / Ford #4 is recommendable.

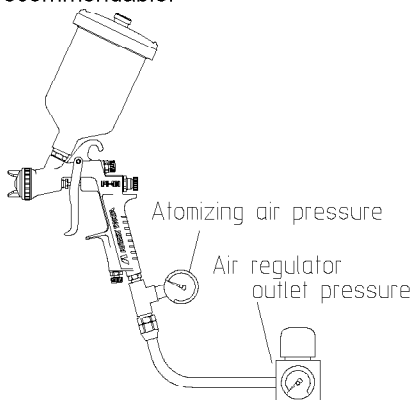
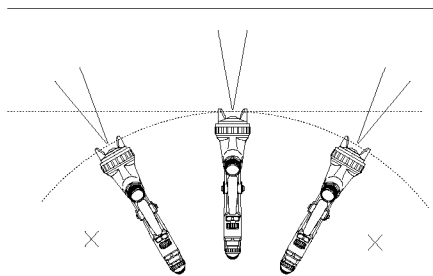

Pulling the trigger of the gun with the pattern adj. set and air adj. set fully opened, adjust the air regulator in the spray booth to obtain 1.0~1.1 bar (14~16 PSI) at the gun inlet as issued on specifications table ahead. In this way the gun will atomize within 0.7 bar (10 PSI) inside air cap.

NOTE

Using air hose 12 m (39.4 ft) long, the inner diameter must be a minimum 8 mm (0.315 in) so the gun can have the correct air volume to atomize at 0.7 bar (10 PSI) inside air cap.

MAINTENANCE AFTER PAINTING

⚠ WARNING







- TURN OFF AIR AND COATING MATERIALS TO THE GUN AND RELEASE PRESSURE BY TRIGGERING THE GUN BEFORE DISASSEMBLING, CLEANING OR SERVICING.
- PAY ATTENTION WHEN DISASSEMBLING SPRAY GUN SINCE YOU MUST TOUCH SHARP PARTS.
- DO NOT DISASSEMBLE WITHOUT RECEIVING ENOUGH KNOWLEDGE AND EDUCATION.

1. Pour remaining paint into another container and then clean paint passages and air cap. Spray a small amount of thinner to clean paint passages. Incomplete cleaning will cause adverse pattern shape and particles. Clean fully and promptly two-component paint after use.
2. Clean other sections with attached brush soaked with thinner and waste cloth.
3. Clean paint passages fully before disassembly.
4. Remove fluid nozzle after removing fluid needle set or while keeping fluid needle pulled, in order to protect seat section.
5. While keeping fluid needle set inserted, tighten fluid needle packing set by hand. Then tighten gradually by spanner.
Adjust packing set while pulling trigger and watching movement of fluid needle set since too much tightening will slow down movement of fluid needle and result in leakage from tip of nozzle.
If tightened too much, turn counterclockwise to the sufficient position without stuck needle and fluid leakage.
6. Turn pattern adj. knob counterclockwise to fully open. And then tighten pattern adj. guide into gun body.

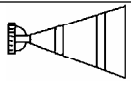
⚠ CAUTION

- NEVER USE COMMERCIAL OR OTHER PARTS INSTEAD OF ANEST IWATA ORIGINAL SPARE PARTS.
- NEVER IMMERSE THE WHOLE GUN INTO LIQUID SUCH AS THINNER.
- NEVER DAMAGE HOLES OF AIR CAP, FLUID NOZZLE AND FLUID NEEDLE.

■ TROUBLESHOOTING

Spray Pattern	Problems	Remedies
 Fluttering	1. Air enters between fluid nozzle and tapered seat of gun body. 2. Air is suctioned from fluid needle packing.	1. Remove fluid nozzle to clean seat. If it is damaged, replace nozzle. 2. Tighten fluid needle packing.
 Crescent	1. Paint buildup on air cap partially clogs horn holes. Air pressure from both horns differs.	1. Remove obstructions from horn holes. But do not use metal objects to clean horn holes.
 Inclined	1. Paint buildup on air cap partially clogs horn hole or air cap center hole, or causes damage. 2. Loose fluid nozzle.	1. Remove obstructions. Replace if damaged. 2. Remove fluid nozzle and clean seated section.
 Split	1. Paint viscosity too low. 2. Fluid output too high.	1. Add paint to increase viscosity. 2. Adjust fluid adj. knob or pattern adj. knob.
 Heavy Center	1. Paint viscosity too high. 2. Fluid output too low.	1. Reduce viscosity. 2. Increase fluid output.
 Spit	1. Fluid nozzle and fluid needle set are not seated properly. 2. The first-stage travel of trigger (when only air discharges) decreases. 3. Paint buildup inside air cap set.	1. Clean or replace fluid nozzle and fluid needle set. 2. Replace fluid nozzle and fluid needle set. 3. Clean air cap set.

R1 : retighten R2 : adjust R3 : clean R4 : replace parts

Problem	Where it occurred	Parts to be checked	Cause	Remedy			
				R1	R2	R3	R4
Air leaks (from tip of air cap)	Air valve set	Air valve	* Dirt or damage on seat			○	○
		Air valve seat set	* Dirt or damage on seat * Wear on air valve spring			○	○
		O ring	* Damage or deteriorated				○
Paint leaks	Fluid nozzle	Fluid nozzle- fluid needle set	* Dirt, damage, wear on seat			○	○
			* Loose fluid needle adj. knob * Wear on needle spring		○		○
			* Insufficient tightening * Dirt or damage on seat	○			○
	Fluid needle- packing set	* Needle does not return due to packing set too tight		○		○	
		* Needle does not return due to paint buildup on fluid needle		○	○		
Fluid needle	Needle packing set- needle set	* Wear	○			○	
	Packing seat	* Insufficient tightening	○				
Paint does not flow	Tip of gun	Fluid adj. knob	* Insufficient opening		○		
		Tip hole of nozzle	* Clogged			○	
		Paint filter	* Clogged			○	○



ANEST IWATA Corporation

3176, Shinvoshida-cho, Kouhoku-ku
Yokohama 223-8501 Japan

Code No. LPH-400-154LV-1